

BY SYNARGY®  
**SMART**  
COMFORT

# JUNO

## MASSAGE CHAIR



**QUICK START GUIDE &  
OPERATING INSTRUCTIONS**

# QUICK START GUIDE

1

Remove your shoes and sit into the chair. You can press down with your feet to extend the footrest length. It is recommended to use the massage chair without wearing jewellery or watches.

2

Press the power button on the remote control, and allow the chair 20-30 seconds to power on. Place your arms inside the arm rests.

3

The chair will automatically enter an automatic massage mode if no buttons are pressed. You can enjoy this mode as it is, or read these operating instructions to learn about more advanced operation.

# BASIC CONTROLS

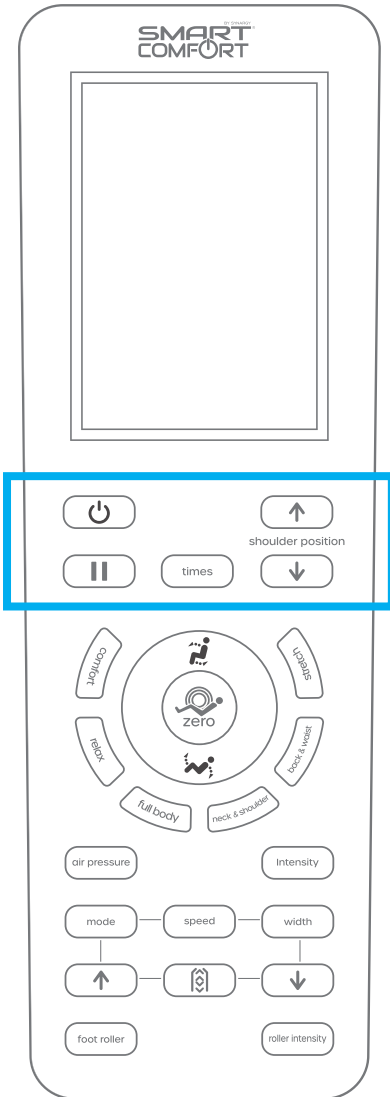

- **Power button** turns the chair on & off. Wait 20-30 seconds for the chair to power on, then select a mode on the remote control. The chair will automatically enter Comfort auto mode if no options are selected.
- **Pause button** stops the massage rollers & functions, until it is pressed again to resume normal function.
- **Times** sets the massage time in 5 minute increments up to 30 minutes.
- **Shoulder position up & down arrows** adjust how far up the shoulders the rollers will travel during shoulder focused movements.

# AUTOMATIC MODE CONTROLS

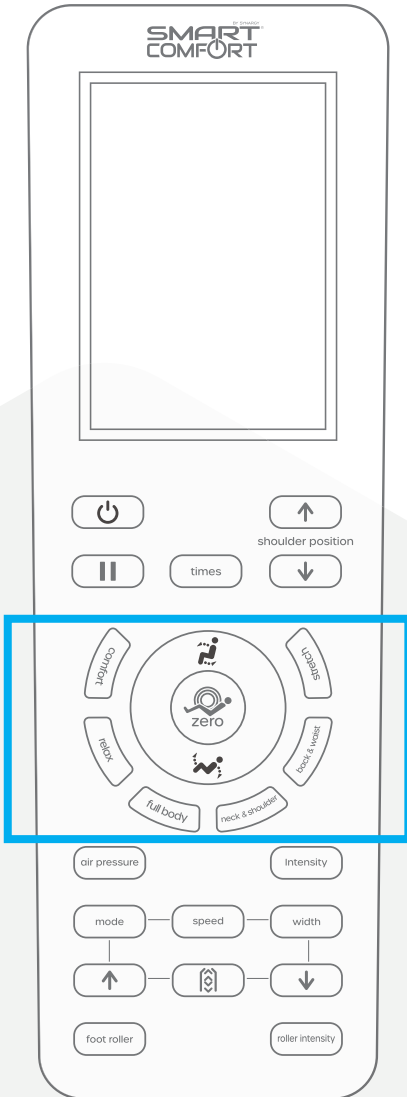



Used for selecting the following automatic massage modes:

- **Comfort** is a gentle mode that targets the whole body
- **Relax** focuses mainly on lower back, legs & feet
- **Full body** focuses on the entire body
- **Neck & shoulder** focuses on the neck & shoulder areas
- **Back & waist** focuses on the back & waist areas
- **Stretch** will lift the footrest and tilt the chair back, while focusing on the legs

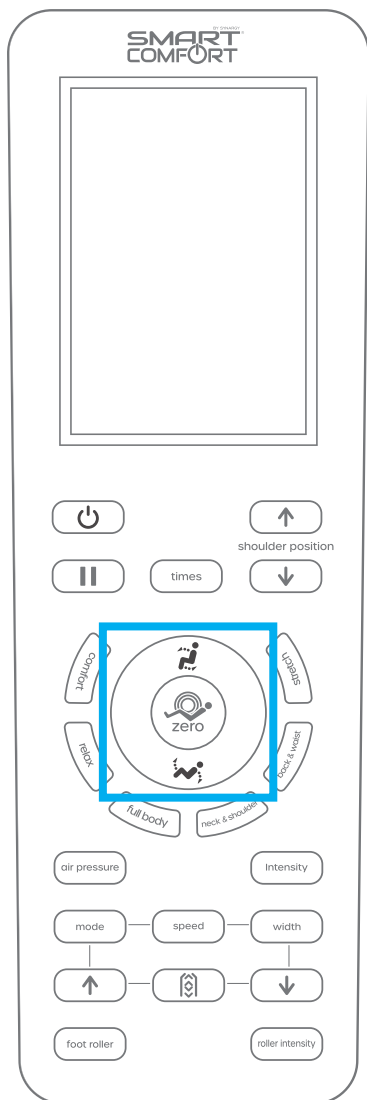
# CHAIR POSITION CONTROLS



Used for selecting the position of the chair:

-  **button** will bring the chair back to upright position. Press to return to upright, or hold and release to fine tune position.
- **Zero button** moves the chair into zero gravity horizontal position
-  **button** will recline the chair backwards. Press to be taken all the way back, or hold and release to fine tune position.

# MANUAL MODE & ADJUSTMENT CONTROLS

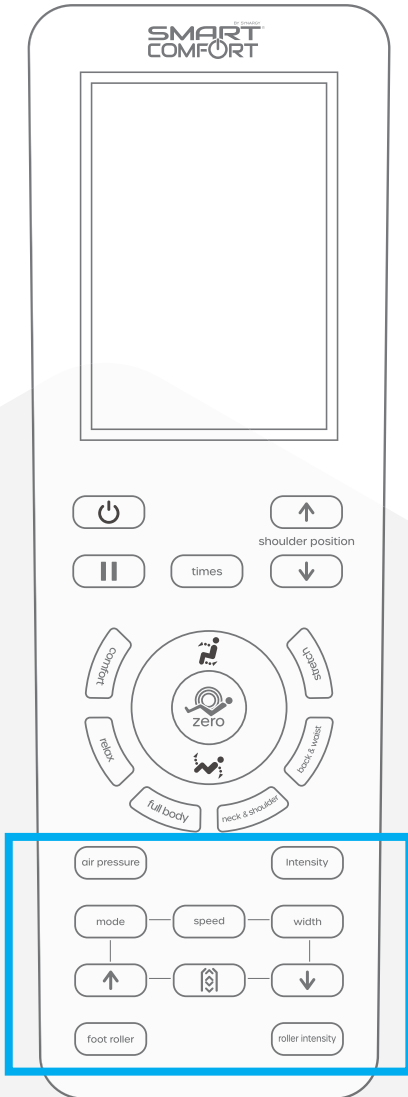

Used for controlling the following functions during manual operation:

- **Air pressure** toggles airbag function between: arms, feet, arms + feet or off. *(can also be adjusted during automatic modes.)*
- **Intensity** adjusts the intensity of pressure from the airbags *(can also be adjusted during automatic modes.)*
- **Mode** changes manual modes between the following, or off:



kneading



shiatsu



tapping



kneading + tapping



knocking

# MANUAL MODE & ADJUSTMENT CONTROLS

- **Speed** adjusts the speed of the massage rollers during manual modes
- **Width** adjusts the width between rollers during shiatsu, tapping or knocking modes
-  (**back mode**) toggles back massage modes between:



H0 fixed position back massage



H3 upper back massage



H1 short area back massage



H4 lower back massage



H2 entire back massage

- **The arrows** either side of back mode will adjust the position of rollers during H0 and H1 back modes
- **Foot roller button** switches the foot roller on & off\*
- **Roller intensity button** switches the foot roller between 3 speed settings\*

*\*can also be adjusted during automatic modes.*

# JUNO MASSAGE CHAIR

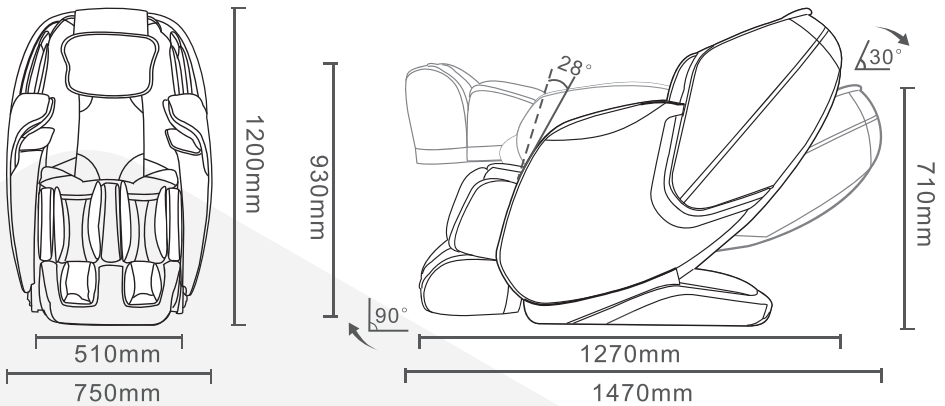

Keep at least 275mm of clear space between the chair backrest and nearby walls or furniture to ensure there is no contact with any items when chair is fully reclined.

**Health and Safety Warnings:** Do not drop or push anything into any slot of the machine. Please stop immediately and consult your doctor if you feel unwell when using this machine. Not intended for use by persons (including children) with reduced physical, sensory or mental capabilities, or lack of experience and knowledge, unless supervised. Do not use if you are pregnant, unwell, or have a pre-existing medical condition. Do not sit on the back, armrest, or the leg rest as it may result in damage or injury. Do not press or put your hands into the cloth cover of the massage hands.